



ELECTRUM NEWS 2020-21

Coordinators:

Dr. Shivashankar
Prof. Santosh Kumar S

Resource person

Dr. Shobha Anand Reddy
Deepak Puranik, Kreedagala
Mr. Harish Lingaiah,

8th-10th Oct 2020

AICTE Sponsored 3-days online workshop On "Personality Development planning skill and Entrepreneurship training"

Under Samridhhi -Scheme

The broad objectives of the programme is to provide opportunity to students in the Institutes to reorient themselves in the light of emerging employment opportunities in Engineering undergraduate/Diploma students at all level. It is to empower the students by providing special skill trainings apart from regular study. To enhance the skills of students with help of modules on communication, personality development and proficiency in English language. It will boost the confidence of students and provide them with better career opportunities so that their employability in the industry increases.

Inside this issue:

3 Days online workshop	1
2 Days online workshop on SPEPD	2
3 Days online workshop	3
1 Days online workshop on H&MT	4
Online Webinar on WE	5
Online Webinar on LAR-WI	6
1 Days online Webinar on seminar on CPSAO	7
1 Days online Webinar on seminar on CPAB&GO	8
STTP under AQIS PGM on DSCN	9
5Days AICTE & ATAL Sponsored TFSCI	10
RTEICT-2020	11

Accredited by NBA*

SVCE BENGALURU

SRI VENKATESHWARA COLLEGE OF ENGINEERING

Affiliated to VTU, Approved by AICTE, Recognised by UGC u/s 2(f) & 12(B)

Sri Venkateshwara College of Engineering

Vidyanagar, Kempegowda International Airport Road, Bengaluru,
Karnataka, India-562157

Department of Electronics & Communication Engineering

(Accredited by NBA)

Organizing

AICTE Sponsored 3-days online workshop on

"Personality Development, Career Planning Skill and Entrepreneurship Training"

Under Samridhhi -Scheme

On 08th to 10th October 2020 (Thursday to Saturday)

Registration is open for all students

Registration Link: <https://forms.gle/wU2geCZQggX4Cvv2A>

YouTube Link: <https://youtu.be/IQm267KnVSo>

Resource Persons:

<p style="color: red; font-weight: bold;">Dr. Shobha Anand Reddy</p> <p style="font-size: x-small;">Director, Trust for Rejuvenation of Environment and Nature Development (TREND), Bengaluru</p> <p style="color: red; font-weight: bold; font-size: 0.8em;">Convener:</p> <p style="font-size: x-small;">Dr. Shivashankar Prof. & Head, Dept. of E&CE, SVCE, Bengaluru</p>	<p style="color: red; font-weight: bold;">Mr. Deepak Puranik</p> <p style="font-size: x-small;">Co-Founder Kreedagala, Bengaluru</p> <p style="color: red; font-weight: bold; font-size: 0.8em;">General Chair:</p> <p style="font-size: x-small;">Dr. Suresha Principal, SVCE, Bengaluru</p>	<p style="color: red; font-weight: bold;">Mr. Harish Lingaiah,</p> <p style="font-size: x-small;">QualComm, Bengaluru</p> <p style="color: red; font-weight: bold; font-size: 0.8em;">Patron:</p> <p style="font-size: x-small;">Dr. Shashidhar Muniyappa Chief Executive Director, Sri Venkateshwara Group of Institutions, Bengaluru</p>
--	---	--

Organizing Committee Members:

<p>Dr. Keshavamurthy, Prof., Dept. of E&CE, SVCE</p> <p>Dr. Jijesh J J, Assoc. Prof., Dept. of E&CE, SVCE</p> <p>Dr. Satyasrikanth Palle, Asst. Prof. E&CE, SVCE</p> <p>Prof. Rajendra Prasad P, Asst. Prof. E&CE, SVCE</p> <p>Prof. Sridhar N K, Asst. Prof. E&CE, SVCE</p> <p>Prof. Arjun Kumar G B, Asst. Prof. E&CE, SVCE</p> <p>Prof. Swathi N, Asst. Prof. E&CE, SVCE</p> <p>Prof. Nataraja N, Asst. Prof. E&CE, SVCE</p> <p>Prof. Avinash J L, Asst. Prof. E&CE, SVCE</p>	<p>Dr. Poornima G R Prof., Dept. of E&CE, SVCE</p> <p>Dr. Dileep Reddy Bolla, Assoc. Prof., E&CE, SVCE</p> <p>Prof. Santosh Kumar S, Asst. Prof. E&CE, SVCE</p> <p>Prof. Sunil Kumar K N, Asst. Prof. E&CE, SVCE</p> <p>Prof. Swapna Ch, Asst. Prof. E&CE, SVCE</p> <p>Prof. Ravi Gatti, Asst. Prof. E&CE, SVCE</p> <p>Prof. Mahaveer Penna, Asst. Prof. E&CE, SVCE</p> <p>Prof. Sarala T, Asst. Prof. E&CE, SVCE</p> <p>Mr. Srikanth S, Dept. of E&CE, SVCE.</p>
--	---

DAY 1

Workshop Inauguration:

Prof. Ravi Gatti, Assistant Professor, Dept. of E&CE, SVCE, Bengaluru, anchored the inaugural session of the workshop in the presence of Dr. Suresha, Principal, SVCE, Bangalore and Dr. Shivashankar, Professor and Head, Department of Electronics & Communication engineering, SVCE, Bangalore

Powered by StreamYard

Accredited by NBA

SVCE BENGALURU
SRI VENKATESHWARA COLLEGE OF ENGINEERING
Affiliated to VTU, Approved by AICTE, Recognized by UGC as 208 & 1208

IGAUCE GOLD

IOACQ

Electronics & Communication Engineering Department
(Accredited by NBA)

Organizing
AICTE SPONSORED 3-DAYS ONLINE WORKSHOP ON
"Personality Development, Career Planning Skill and
Entrepreneurship Training"
Under Samridhhi -Scheme
On 08th to 10th October 2020

Prof. Ravi Gatti
Dr. Suresha
Dr. Shivashankar
Dr. Keshavamurthy

Workshop Training" Under Samridhhi -Scheme : on 08 -10th October 2020

Powered by StreamYard

Accredited by NBA

SVCE BENGALURU
SRI VENKATESHWARA COLLEGE OF ENGINEERING
Affiliated to VTU, Approved by AICTE, Recognized by UGC as 208 & 1208

IGAUCE GOLD

IOACQ

Electronics & Communication Engineering Department
(Accredited by NBA)

Organizing
AICTE SPONSORED 3-DAYS ONLINE WORKSHOP ON
"Personality Development, Career Planning Skill and
Entrepreneurship Training"
Under Samridhhi -Scheme
On 08th to 10th October 2020

Dr. Keshavamurthy, Professor & Controller of
Examination, Sri Venkateshwara College of Engineering,
Bengaluru.

Dr. Keshavamurthy
Dr. Suresha

Workshop Training" Under Samridhhi -Scheme : on 08 -10th October 2020

Powered by StreamYard

Accredited by NBA

SVCE BENGALURU
SRI VENKATESHWARA COLLEGE OF ENGINEERING
Affiliated to VTU, Approved by AICTE, Recognized by UGC as 208 & 1208

IGAUCE GOLD

IOACQ

Electronics & Communication Engineering Department
(Accredited by NBA)

Organizing
AICTE SPONSORED 3-DAYS ONLINE WORKSHOP ON
"Personality Development, Career Planning Skill and
Entrepreneurship Training"
Under Samridhhi -Scheme
On 08th to 10th October 2020 (Thursday to Saturday)

Resource person:
Dr. Shobha Anand Reddy,
Director, Trust for Rejuvenation of Environment
and Nature Development (TREND), Bengaluru

Dr. Shobha Anand Reddy, Director, Trust for
Rejuvenation of Environment and Nature , Bengaluru

Dr. Keshavamurthy
Dr. Suresha

Welcome to AICTE sponsored 3-days online workshop on "Personality Development, Career Planning Skill and Entrepreneurship Training" Under Samridhhi -Scheme : on 08 -10th October 2020

Powered by StreamYard

Accredited by NBA

SVCE BENGALURU
SRI VENKATESHWARA COLLEGE OF ENGINEERING
Affiliated to VTU, Approved by AICTE, Recognized by UGC as 208 & 1208

IGAUCE GOLD

IOACQ

Electronics & Communication Engineering Department
(Accredited by NBA)

Organizing
AICTE SPONSORED 3-DAYS ONLINE WORKSHOP ON
"Personality Development, Career Planning Skill and
Entrepreneurship Training"
Under Samridhhi -Scheme
On 08th to 10th October 2020

Dr. Shobha Anand Reddy, Director, T
Dr. Keshavamurthy
Dr. Suresha

Workshop Training" Under Samridhhi -Scheme : on 08 -10th October 2020

Powered by StreamYard

Learning Objectives

- At the end of this workshop, the participants will be able to:
 - Ask SPIN questions to identify and fulfill buyer needs - *increased customer satisfaction*
 - Use the customer-centric consultative sales SPIN calls techniques - *increased sales force effectiveness*

Deepak Puranik

Workshop Training" Under Samridhhi -Scheme

Session 1: Resource person Mr. Deepak Puranik, the Co-Founder at KreedaGala presented session on "Own your mindset". Sir focussed on reality and practical examples of the current situations of the people mind sets. Sir explored and differentiated about fixed mind set and Growth mindset and some glimpse of Johari window and service mindset.

Entrepreneur Characteristics

- Accountability
- Crisis Management
- Versatile

26 Qualities of Successful Entrepreneurs

Board Characteristics	Qualities or Traits
Self Confidence	1. Confidence
	2. Independence
	3. Individuality
	4. Optimism
Task or Result Oriented	5. Need for achievement
	6. Multi-oriented
	7. Persistent
	8. Deterministic
	9. Hard work
	10. Drive
	11. Energy
	12. Determination
	13. Initiative
Risk Taker	14. Risk taking ability
	15. Like challenges
Leadership	16. Leadership behavior
	17. Gets along well with others
	18. Responsive to suggestions and criticism
Originality	19. Innovative
	20. Creative
	21. Flexible
	22. Resourceful
	23. Versatile
	24. Knowledge
Future Oriented	25. Foresight
	26. Perceptive

Dr. Shobha Reddy, Director, TR...

“Career Planning Skill and Entrepreneurship Training” Under Samridhhi -Scheme

SPIN SELLING WELCOME

Dr. Shobha Reddy, Director, T...

Deepak Puranik

AICTE Sponsored 3-days online workshop on “Personality Dev

Session 2: Resource person Dr. Shobha Anand Reddy madam delivered session on Career Planning and Entrepreneurship skills. Madam emphasised on different facets of the career, interesting concept of Ikigai, Some of characteristics of Entrepreneur such as accountability, crisis management, versatile.

Mr. Deepak Puranik sir addressing on Selling skills and how the SPIN selling puts the potential customer at the center of the sales process. Rather than stating the value of your solution, you lead the prospect to understanding that value on their own by asking well developed questions. And how to prepare business case for SPIN selling

SVCE BENGALURU
 SVCE BENGALURU
 SVCE BENGALURU
 SVCE BENGALURU

Electronics & Communication Engineering Department
 (Accredited by NBA)

Organizing
 AICTE SPONSORED 3-DAYS ONLINE WORKSHOP ON
 “Personality Development, Career Planning Skill and
 Entrepreneurship Training”
 Under Samridhhi -Scheme
 On 08th to 10th October 2020 (Thursday to Saturday)

Resource Person:
 Mr. Harish Lingaiah,
 Senior Technical Manager
 Qualcomm Technologies, Bangalore

**Mr. Harish Lingaiah, Senior Technical Manager,
 Qualcomm Bengaluru**

workshop on “Personality Development, Career Planning Skill and Entrepreneurship Training”

What we do in Electronics Industries

- Electronics system design for various applications
- Electronics Components design
- Embedded Software development
- Customer Support and maintenance
- EDA tools development

Harish Lingaiah

Under Samridhhi -Scheme

AICTE Sponsored 3

Prof. Ravi Gatti, Assistant Professor, Dept. of E&CE, SVCE, Bengaluru, introducing the Key note speaker Mr. Harish Lingaiah, Senior technical manager, Qualcomm Bengaluru

Session 4: Resource person was Mr. Harish Lingaiah, Sir emphasised on what are the different roles played by EC engineers in various domain. Sir addressed on Electronics system design, Electronics component design, Digital IC design and Customer support and EDA tools.



Career Planning Skill and Entrepreneurship Training" Under Samridhi - Scheme



Career Planning Skill and Entrepreneurship Training" Under Samridhi - Scheme



Feedback form for AICTE Sponsored 3 days Online Workshop on "Personality Development, Career Planning Skill and Entrepreneurship Training" Under Samridhi - Scheme.

Organized by Department of Electronics & Communication Engineering (Accredited by NBA), Sri Venkateshwara College of Engineering, Vidyanagar, Kempegowda International Airport road, Bengaluru, Karnataka, India-562157

Email address *

Valid email address

Question

Option 1

Organized by Department of Electronics & Communication Engineering (Accredited by NBA), Sri Venkateshwara College of Engineering, Vidyanagar, Kempegowda International Airport road, Bengaluru, Karnataka, India-562157



Resource Person: Dr. Shobha Anand Reddy, Director, Trust for Rejuvenation of Environment and Nature Development (TREND), Bangalore, India. Session Talk on: "Career Planning and Entrepreneurship skills"



Name of the Participant:s *

Short answer text

College Name/ Industry: *

Short answer text

Relevance of the Topic *

Strongly Agree

Agree

Neutral

Disagree

Responses cannot be edited

Feedback form for AICTE Sponsored 3 days Online Workshop on "Personality Development, Career Planning Skill and Entrepreneurship Training " Under Samriddhi - Scheme.

Organized by Department of Electronics & Communication Engineering (Accredited by NBA), Sri Venkateshwara College of Engineering, Vidyanagar, Kempegowda International Airport road, Bengaluru, Karnataka, India-562157

* Required

Email address *

lycian998@gmail.com

Option 1

Organized by Department of Electronics & Communication Engineering (Accredited by NBA), Sri Venkateshwara College of Engineering, Vidyanagar, Kempegowda International Airport road, Bengaluru, Karnataka, India-562157



College Name/ Industry : *

Atria Institute of Technology

Relevance of the Topic *

Strongly Agree

Agree

Neutral

Disagree

Training Methodology *

Strongly Agree

Agree

Neutral

Disagree

The training objectives were met *

Strongly Agree

Agree

Neutral

Disagree

HEAD, DEPT. OF E & CE
SRI VENKATESHWARA
COLLEGE OF ENGINEERING
BANGALORE-562 157

6th-7th Oct 2020

TWO DAYS ONLINE HANDSON WORKSHOP ON "SKILL AND PERSONALITY ENHANCEMENT FOR PROFESSIONAL DEVELOPMENT" UNDER THE SCHEME OF "SKILL AND PERSONALITY DEVELOPMENT PROGRAMME (SPDP)"

Coordinators:

Dr. Shivashankar

Prof. Mahaveer
Penna

Resource person

Mr. Anil Kumar

SVCE BENGALURU
SRI VENKATESHWARA COLLEGE OF ENGINEERING
Affiliated to VTU, Approved by AICTE, Recognised by UGC u/s 2(f) & 12(B)

Accredited by NBA*

INSTITUTION'S INNOVATION COUNCIL (Ministry of HRD Initiative)
I-GAUGE INDIAN UNIVERSITY RATING GOLD

ARIIA ATAL RANKING OF INSTITUTIONS ON INNOVATION ACHIEVEMENTS

Sri Venkateshwara College of Engineering
Vidyanagar, Kempegowda International Airport Road, Bengaluru,
Karnataka, India-562157
Department of Electronics & Communication Engineering
(Accredited by NBA)
Organizing
AICTE Sponsored 2-days online workshop on
"Skill and Personality Enhancement for Professional Development"
Under Skill and Personality Development Program (SPDP)-Scheme
On 06th & 07th October 2020 (Tuesday & Wednesday)
Registration is open for all students
Free Registration Link: <https://forms.gle/BaEkQ8zUadmZLnf89>
Go To Webinar Link: https://www.gotomeet.me/mahaveerpenna_ece/new-meeting

Resource Person: Mr. Anil Kumar, Sr. Software Engg., Bengaluru

Convener:
Dr. Shivashankar
Prof. & Head,
Dept. of E&CE, SVCE, Bengaluru

General Chair:
Dr. Suresha
Principal, SVCE,
Bengaluru

Patron:
Dr. Shashidhar Muniyappa
Chief Executive Director,
Sri Venkateshwara Group of Institutions,
Bengaluru

Organizing Committee Members:

Dr. Keshavamurthy, Prof., Dept. of E&CE, SVCE	Dr. Poornima G R Prof., Dept. of E&CE, SVCE
Dr. Jijesh J J, Assoc. Prof., Dept. of E&CE, SVCE	Dr. Dileep Reddy Bolla, Assoc. Prof., E&CE, SVCE
Dr. Satyasrikanth Falke, Asst. Prof. E&CE, SVCE	Prof. Santosh Kumar S, Asst. Prof. E&CE, SVCE
Prof. Rajendra Prasad P, Asst. Prof. E&CE, SVCE	Prof. Sunil Kumar K N, Asst. Prof. E&CE, SVCE
Prof. Sridhar N K, Asst. Prof. E&CE, SVCE	Prof. Swapna Ch, Asst. Prof. E&CE, SVCE
Prof. Arjun Kumar G B, Asst. Prof. E&CE, SVCE	Prof. Ravi Gatti, Asst. Prof. E&CE, SVCE
Prof. Swathi N, Asst. Prof. E&CE, SVCE	Prof. Mahaveer Penna, Asst. Prof. E&CE, SVCE
Prof. Nataraja N, Asst. Prof. E&CE, SVCE	Prof. Sarala T, Asst. Prof. E&CE, SVCE
Prof. Avinash J L, Asst. Prof. E&CE, SVCE	Mr. Srikanth S, Dept. of E&CE, SVCE.

The online two days' workshop focuses mainly to enhance the skill and personality development amongst the SC/ST students under SPDP scheme sponsored by the prestigious AICTE- New Delhi, the event under the facilitation of the eminent speaker from the industry allured all the participants, several aspects were discussed by the resource person in terms of skill and personality development, total of four sessions were conducted under this event, where each session focuses on different lecturer's and activities of skill and personality develop-

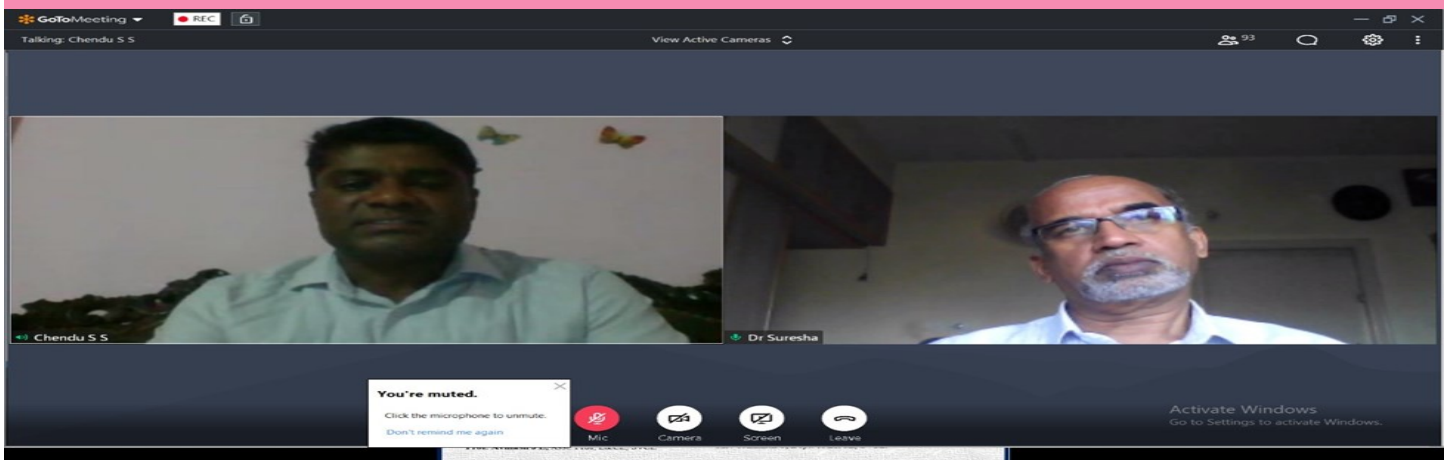

GoToMeeting REC 6

Talking: Chendu S S View Active Cameras 94 ENG 06-10-2020

Anil Kumar Chendu S S Dr Suresha

You're muted.
Click the microphone to unmute.
Don't remind me again

Mic Camera Screen Leave

Activate Windows
Go to Settings to activate Windows.

GoToMeeting REC 6

Talking: Anil Kumar H (082/ECAA) View Everyone 94 ENG 06-10-2020

Anil Kumar H (082/ECAA) is presenting

Mic Camera Screen Leave

Activate Windows
Go to Settings to activate Windows.

2:38 PM
10/7/2020

GoToMeeting REC 6

Talking: Anil Kumar View Everyone 94 ENG 06-10-2020

GROUP DISCUSSION

- How you will communicate, behave and interact with others
- Listening skills
- Leadership and decision-making skills
- Attitude and confidence
- Problem solving and critical thinking skill

Anil Kumar is presenting

Mic Camera Screen Leave

Activate Windows
Go to Settings to activate Windows.

1:40 PM
10/6/2020



**HEAD, DEPT. OF E & CE
SRI VENKATESHWARA
COLLEGE OF ENGINEERING
BANGALORE-562 157**

Online Webinar on “Women in Engineering” under SVCE women welfare committee

During her presentation, Dr.Rathna G N highlighted few women successors and key factors towards their success and their contributions towards the society. In her presentation she mainly focused on research thrust areas, research work on Indian sign languages, denoising, mm-wave RADAR, nerve detection algorithms and also funding schemes available for Women in Govt. and other private sectors.

Coordinators:

Dr. Shivashankar

Dr.Poornima G R

Resource person

Dr.Rathna G N



Sri Venkateshwara College of Engineering

Vidyanagar, Kempegowda International Airport Road, Bengaluru,
Karnataka, India- 562 157

SVCE Women Welfare Committee

Cordially invites you for

Webinar on

“Women in Engineering ”

On 04th November 2020 (Wednesday)

Time: 2.00 pm to 4.00 pm

Registration is open for all female Professors, Scientist, Lecturers, Researchers,
Teachers, Students & etc.,

Registration Link: <https://tinyurl.com/y5dvuzbs>

YouTube Link: <https://www.youtube.com/watch?v=iKihSCTKil8>



Convener:
Women Welfare Committee
SVCE, Bengaluru

Resource Person:

Prof. Dr. Rathna G N
Principal Research Scientist,
IEEE Senior Member
IISc, Bangalore

General Chair:

Dr. Suresha
Principal, SVCE,
Bengaluru

Patron:

Dr. Shashidhar Muniyappa
Chief Executive Director,
Sri Venkateshwara Group of Institutions,
Bengaluru

Organizing Committee Members:

Faculty Members

Dr. Poornima G-R Prof., Dept. of E&CE, SVCE
Prof. Varsha Kulkarni Asst. Prof., Dept. of CSE, SVCE
Dr. Shobha M, Prof. & HoD, Dept. of ISE, SVCE
Dr. Vijayashree Budyal, Prof. & HoD, EEE&MT, SVCE
Dr. Latha M S, Prof., Dept. of CVE, SVCE
Prof. Ramani Krishnan, Asst. Prof., Dept. of BS
Prof. Akshatha S, Asst. Prof., Dept. of MBA
Mrs. Saritha S, SDA, Office

Student Members

Ms. Varshini J S, Dept. of ECE
Ms. Namratha K S, Dept. of CSE
Ms. Charana R B, Dept. of ISE
Ms. Prarthana Panda, Dept. of ME
Ms. Vaishnavi G, Dept. of CVE

Figure 2 Inaugural Session by Dr.Suresha, Principal, SVCE

Powered by StreamYard

Accredited by NBA

SVCE BENGALURU

SRI VENKATESHWARA COLLEGE OF ENGINEERING
Affiliated to VTU, Approved by AICTE, Recognized by UGC as 205 & 12(B)

INSTITUTION'S INNOVATION COUNCIL

SVCE

ARIIA
ATLAS BARING OF INSTITUTE'S ON INSTITUTE'S ACHIEVEMENTS

IGQUGE
GOLD

Sri Venkateshwara College of Engineering
Vidyanagar, Kempegowda International Airport Road, Bengaluru,
Karnataka, India- 562 157

SVCE Women Welfare Committee

Cordially invites you for
Webinar on
"Women in Engineering"
On 04th November 2020 (Wednesday)
Time: 2.00 pm to 4.00 pm

Registration is open for all female Professors, Scientist, Lecturers, Researchers,
Teachers, Students & etc.,

Registration Link: <https://forms.gle/3d8v5t1q>

YouTube Link: <https://www.youtube.com/watch?v=IKh5C7X1s>

Resource Person:
Prof. Dr. Rathna G N
Principal Research Scientist,
IEEE Senior Member
IISc, Bangalore

General Chair:
Dr. Suresha
Principal, SVCE,
Bengaluru

Patron:
Dr. Shashidhar Muniyappa
Chief Executive Director,
Sri Venkateshwara Group of Institutions,
Bengaluru

Chairman:
Women Welfare Committee
SVCE, Bengaluru

Participants in the Zoom grid:
- Rathna
- Kulkarni Varsha, Dept. of CSE, SV...
- Dr. Poomima G R
- Dr Suresha

Powered by StreamYard

Dr. Rathna G N, Principal Research Scientist, IEEE Senior Member, IISc, Bengaluru.

Women in Engineering, Cordially invites you for Webinar

10:55 / 1:44:30

Women in Engineering

311 views • Streamed live on Nov 4, 2020

24 1 SHARE SAVE ...

Figure 3 Session by Dr. Rathna G N, Principal Research Scientist, IISc, Bengaluru

Indian Sign Language (Pratik Likhari and Neel Kamal)



Indian Institute of Science
Bangalore, India



Image Denoising Bilateral Filter

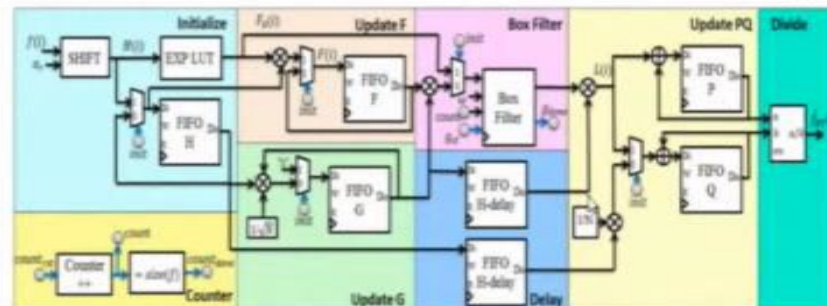

A Reconfigurable and Scalable FPGA Architecture for Bilateral Filtering

Publication

S. S. Sathya G. N. Rathna, K. N. Chaudhury, "A Reconfigurable and Scalable FPGA Architecture for Bilateral Filtering," IEEE Transactions on Industrial Electronics, Volume 65, No. 2, pp. 1459-1469, February 2018.

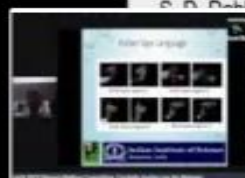

Indian Institute of Science
Bangalore, India



Profession

230 responses

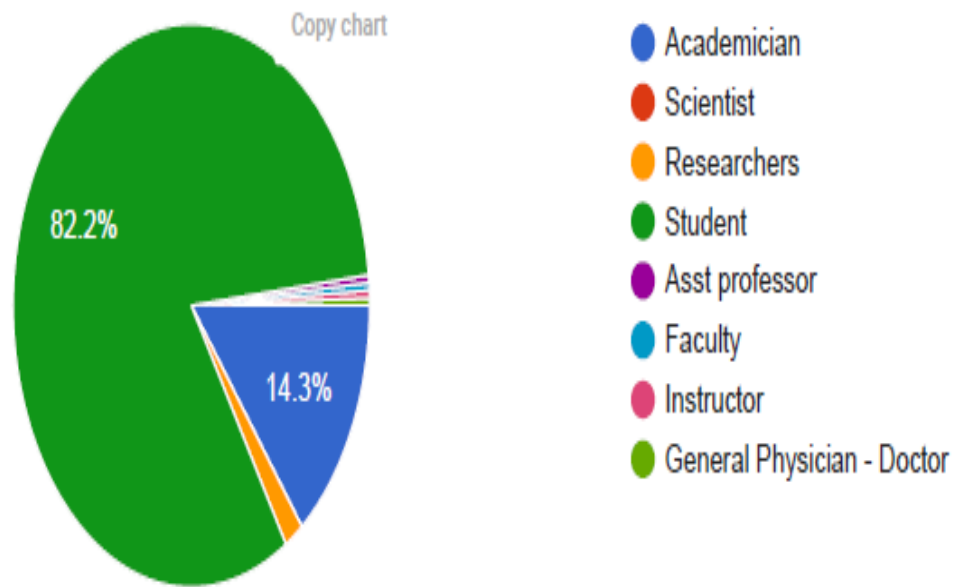

25 responses

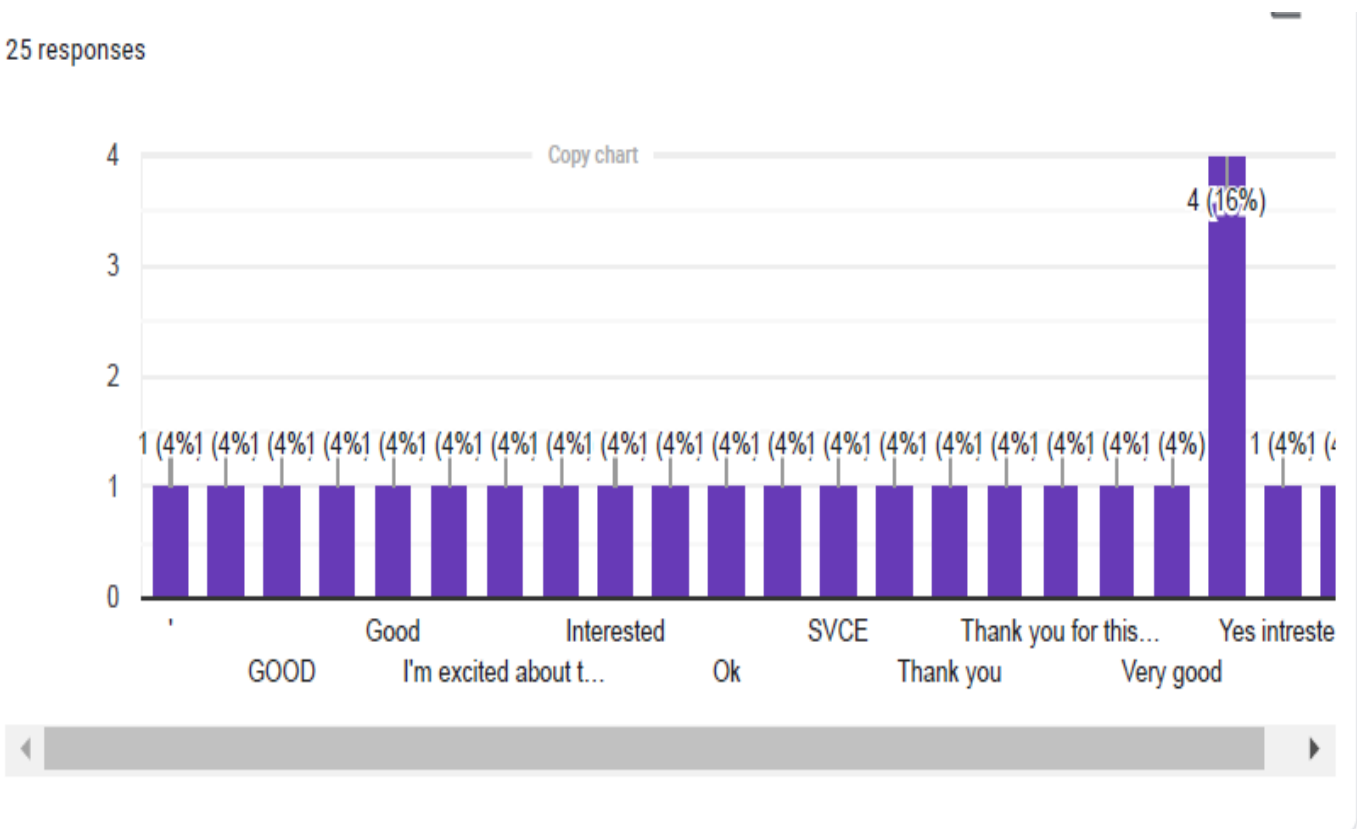

Webinar on Topic

“Legal awareness of the rights of women in India”

Under SVCE Anti-Sexual Harassment Committee

constituted a Sexual Harassment prevention Committee and Sexual Harassment Prevention squad committee to abreast the policy updation from Govt., or statutory bodies and also to organize the awareness programs for women employees and Girl students of UG, PG, Doctoral degrees. The Institutes sexual harassment prevention committee and squad committee monitors any complaints or grievances from either the girl student’s or women employee in the campus. Often within the campus squad committee will be visiting and same shall be reporting to the top management. Based on seriousness of the complaint action will be initiated.

Coordinators:

Dr. Shivashankar

Dr. Poornima G R

Resource person

Mr. Anubha Shrivastav



Accredited by NBA*

SVCE BENGALURU

SRI VENKATESHWARA COLLEGE OF ENGINEERING
Affiliated to VTU, Approved by AICTE, Recognised by UGC u/s 2(f) & 12(B)



Sri Venkateshwara College of Engineering
Vidyanagar, Kempegowda International Airport Road,
Bengaluru, Karnataka, India- 562 157
Anti – Sexual Harassment Committee, SVCE
Cordially invites you for
Webinar on

“LEGAL AWARENESS OF THE RIGHTS OF WOMEN IN INDIA”

On 06th November 2020 (Friday)
Time: 2.00 pm to 4.00 pm

Registration is open for all female Professors, Scientist, Lecturers, Researchers,
Teachers, Students & etc.,

Registration link: <https://forms.gle/9A6M4XYqGr8cXFvV8>
YouTube link: <https://www.youtube.com/watch?v=ggUXfaMGnKA>



Resource Person:
Anubha Shrivastav
Legal Associate
Founder of AS Legal Associate

Convener:
Anti-Sexual Harassment
Committee, SVCE, Bengaluru
Anti-Sexual Harassment Squad
Committee, SVCE, Bengaluru

General Chair:
Dr. Suresha,
Principal, SVCE,
Bengaluru

Patron:
Dr. Shashidhar Muniyappa
Chief Executive Director,
Sri Venkateshwara Group of Institutions,
Bengaluru

Organizing Committee Members:

<p>Anti-sexual Harassment Committee members</p> <p>Dr. Poornima G R Prof., Dept. of E&CE Prof. Varsha Kulkarni Asst. Prof., Dept. of CSE Dr. Shobha M, Prof. & HoD, Dept. of ISE Ms. Kursheed B, Asst. Prof., Dept. of MT Dr. Latha M S, Prof, Dept. of CVE, SVCE Dr. Ch. Mamatha, Prof., Dept. of BS Dr. Rajkumar H N, Prof. & HoD, Dept. of CE Dr. Panchakshari, Prof., Registrar, Dept. of ME Mrs. Saritha S, SDA, Office</p>	<p>Anti-sexual Harassment Squad Committee members</p> <p>Dr. Renuka R Patil, Asst. Prof., Dept. of CSE Mrs. Sarala T, Asst. Prof., Dept. of ECE Ms. Nayana B P, Asst. Prof., Dept. of ISE Mrs. Ramya P, Asst. Prof., Dept. of MT Mrs. Shwetha Shetty M R, Asst. Prof., Dept. of CE Mrs. Jyothi N Rayar, Asst. Prof., Dept. of BS Mrs. Saritha S, SDA, Office</p>
---	---

6th Nov 2020

Powered by StreamYard

Accredited by NBA
SVCE BENGALURU
SRI VENKATESHWARA COLLEGE OF ENGINEERING
Affiliated to VTU, Approved by AICTE, Recognized by UGC a/s 2(f) & 12(B)

INSTITUTIONS' ASSOCIATION COUNCIL
ARIIA
LGAUGE GOLD

Anti – Sexual Harassment Committee, SVCE
Cordially invites you for Webinar on
"LEGAL AWARENESS TO THE RIGHTS OF WOMEN IN INDIA"
On 06th November 2020 (Friday)
Time: 2.00 pm to 4.00 pm

Resource Person:
Anubha Shrivastav
Legal Associate
Founder of AS Legal Associate

Advocate Anubha 9902700155
Dr. Pournima G R
Dr. Suresha

1:01 / 1:02:44

Legal awareness to the rights of women in India

YouTube TV Search 19 0 SHARE SAVE ...

Powered by StreamYard

Anubha Shrivastav Legal Associate Founder of AS Legal Associate

18:04 / 1:02:44

Legal awareness to the rights of women in India

191 views • Streamed live on Nov 6, 2020

19 0 SHARE SAVE ...

Powered by StreamYard

Dr Suresha

4:05 / 1:02:44 Sri Venkateshwara College of Engineering, organizing web

Legal awareness to the rights of women in India

191 views • Streamed live on Nov 6, 2020

19 0 SHARE SAVE ...

Figure 3 Address by Mrs. Anubha Shrivastav

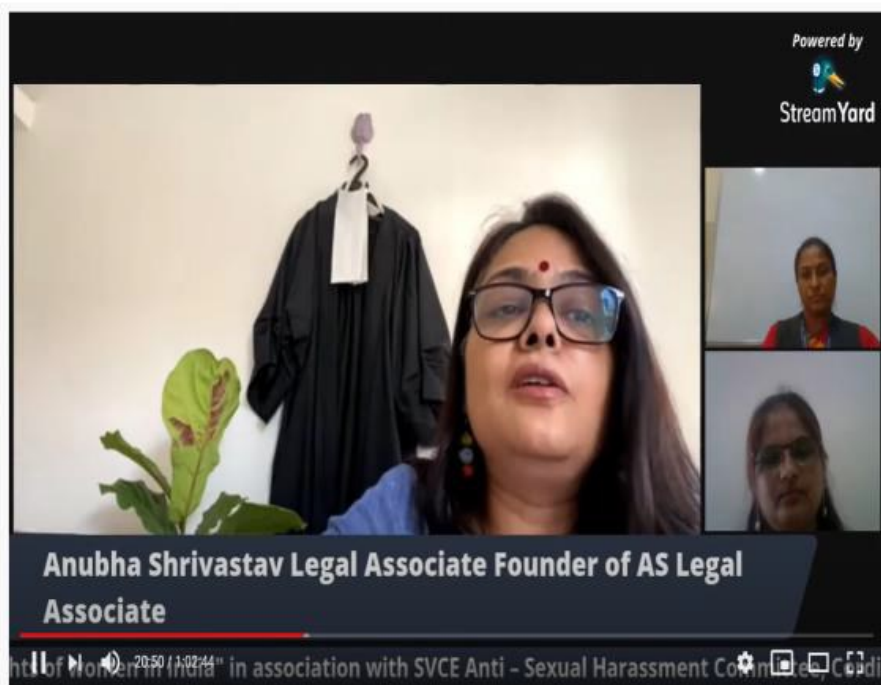

Figure 4 Concluding Session

Legal awareness to the rights of women in India

191 views • Streamed live on Nov 6, 2020

19 0 SHARE SAVE ...

Mrs. Anubha Srivastav highlighted the various laws i.e., constitutional rights and constitutional laws with clear differences, various articles of law associated with rights of Women as per Constitution of India, Penal Code, article 19- freedom rights, article 21- life and liberty, Article 21 A-right to education, Article 22- right of a Women when they arrested, various clauses in law to take care the sexual harassments, punishments enforced on crimes etc.,

Profession

169 responses

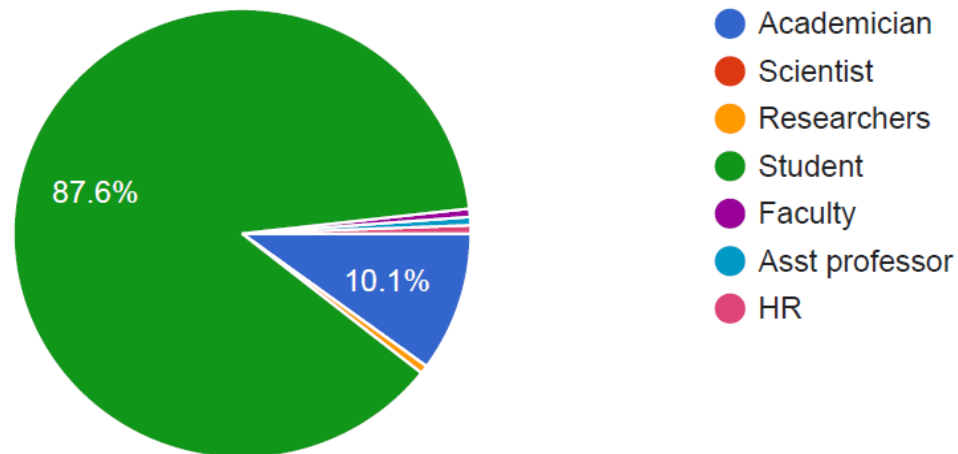

The exemplary talk was continued for almost 1 hour and concluded by thanking resource person.

A Report by SHPC & AHPSC committees

